

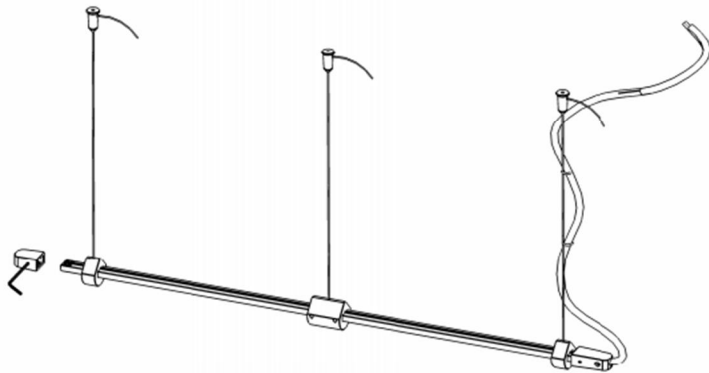

Connect the tracks using the Allenkey and push the cap to hide the connection.

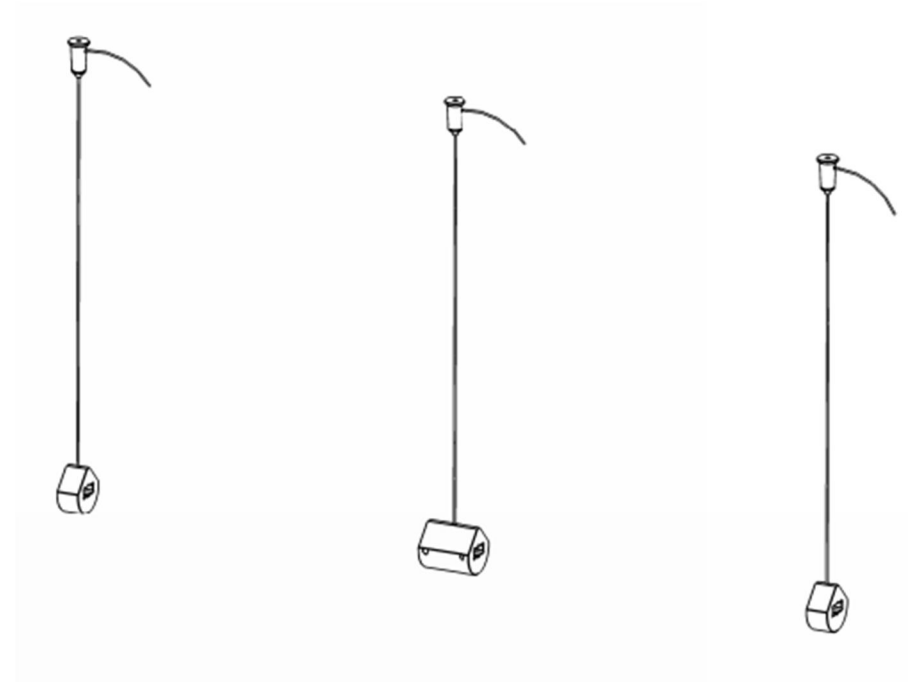

Mount End cap and fasten the set screw.



Suspended set 1.5 m up to 3 m

User manual  
Item nr: 11488009

# RobLight

## Mounting

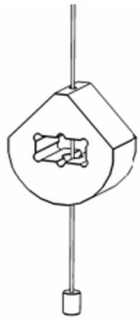
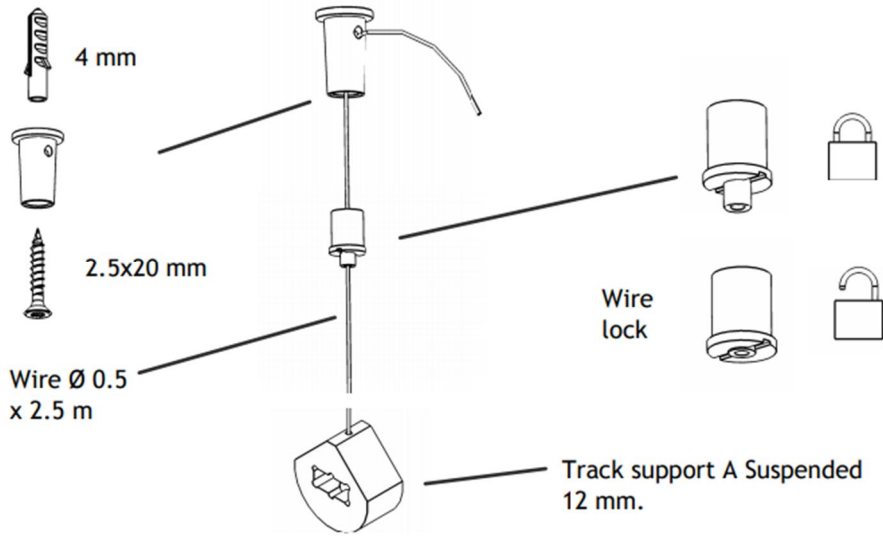

Lead the wire up through the Track support from the bottom until it reaches the top and the square hole is not blocked.



Put the O-rings on the wire.



Set the wire lock on the wire and mount the electrical wire through the O-rings.



Mount the wire lock fitting on the ceiling and screw the wire lock into the fitting.

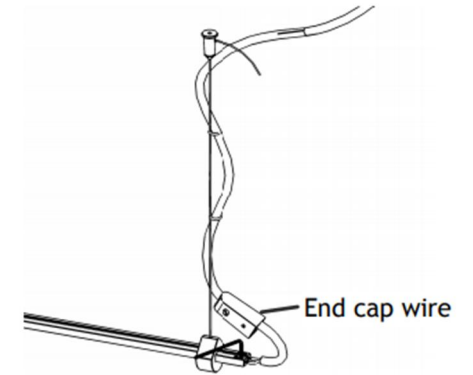
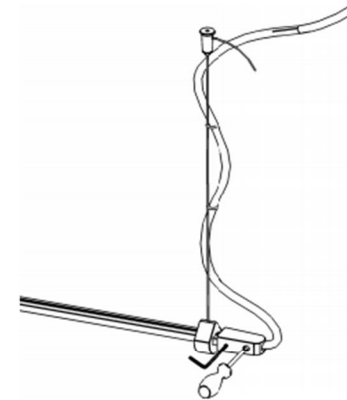
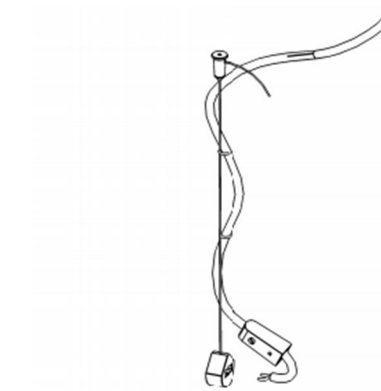

Mount electrical wire through the End cap. Fasten the electrical wire in the Track and lock with set screws. Fasten the End cap with set screw and the relief of electrical wire with a screwdriver.

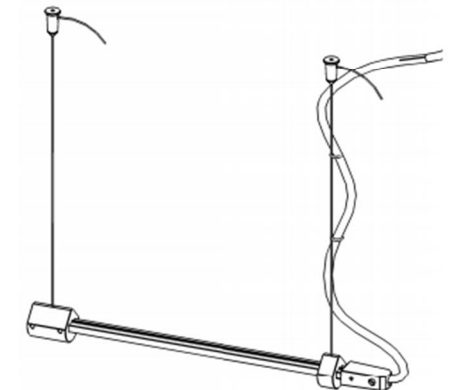

Put the Track A through the other Track A Suspended.